

# SCIEX Triple Quad™ 5500+ LC-MS/MS System

QTRAP® Ready

Quantitative Performance  
by Design



# Introducing the SCIEX Triple Quad 5500+ System

## Built for Quantitative Performance

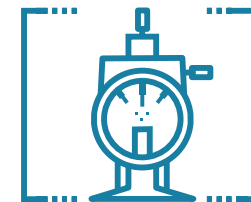

**The SCIEX Triple Quad 5500+ LC-MS/MS System – QTRAP Ready continues the SCIEX legacy of groundbreaking innovations for quantitative performance**

Combining patented mass spec technologies with sophisticated yet intuitive software, the SCIEX Triple Quad 5500+ System delivers a high level of sensitivity, robustness and productivity for the most demanding quantitative analyses. This LC-MS/MS system will help you respond to low-level trace detection and quantification challenges with ease while meeting regulatory requirements.



Pharma &  
Biopharma



Food & Beverage  
Testing



Environmental  
Testing



Life Science &  
Clinical Research



For more information, visit: [sciex.com/5500plus](https://sciex.com/5500plus)

# Engineered for **Enhanced Quantitative Performance**

## Patented Curtain Gas™ Interface

Proven protection against mass spec contamination providing consistent data quality over long runs with minimal downtime.

## Patented Dual QJet® Ion Guide

Improved ion sampling, collisional focusing and ion transmission for outstanding sensitivity.

## High Energy Dynode (HED) Detector

Extended dynamic range up to 6 orders of magnitude and fast polarity switching of 5 msec for an increased sample throughput.

## Patented Linear Accelerator™ Trap

Activation of QTRAP functionality offers extra linear ion trap functionality delivering advanced MS<sup>3</sup> qualitative results and unprecedented selectivity for the most challenging analytical assays.

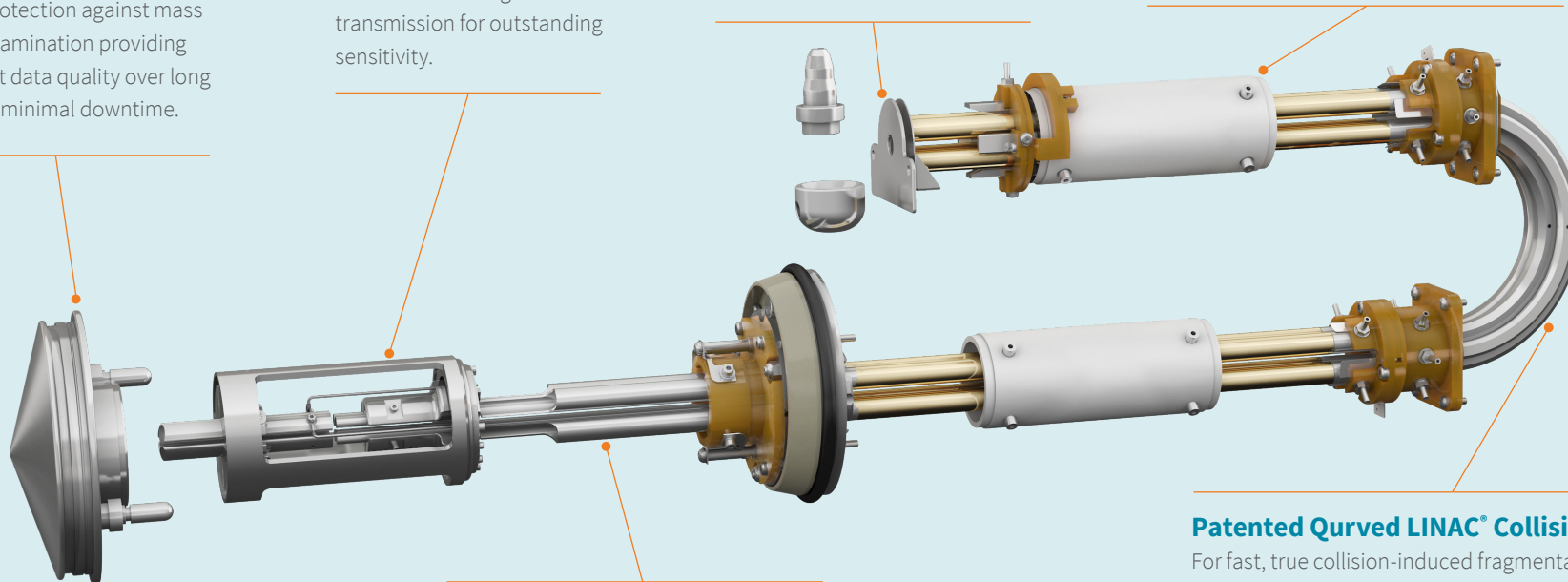

## Patented Q0 High Pressure Cell

High pressure collisional focusing technology enhancing ion transmission for improved sensitivity.

## Patented Curved LINAC® Collision Cell

For fast, true collision-induced fragmentation generating reliable, information-rich, library-searchable MS/MS spectra time after time. Ideal for UHPLC and high throughput analyses with hundreds of compounds.

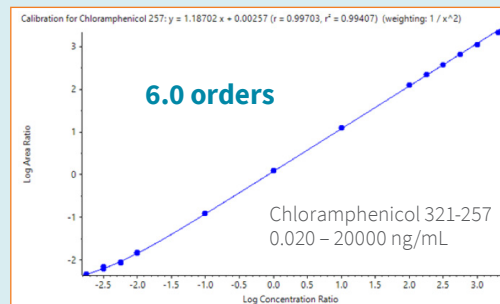

Extended linear dynamic range to 6 orders of magnitude

# Behind Every Exceptional Mass Spec is an Exceptional Ion Source

Rugged, reliable, easily interchangeable ion sources are available for a wide range of applications and flow rates to suit your analysis needs. Rapid source change-over extends system flexibility with minimum downtime. All temperature, gas, and electrical connections are fully integrated into the source housing—no extra lines to attach and no lost time. The system automatically detects and identifies the source without having to make hardware profile changes.

## Turbo V™ Ion Source – Robustness and Flexibility for all Your Analytical Workflows

- **Extraordinary robustness in performance**

The simplistic source architecture and orthogonal spray design provides uniform temperature distribution and optimized curtain gas flow to improve robustness and ruggedness

- **Versatile flow ranges**

Covering flow ranges of 5  $\mu\text{L}/\text{min}$  to 3  $\text{mL}/\text{min}$

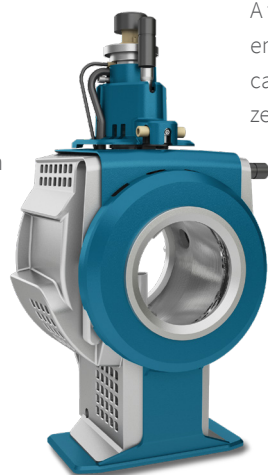

- **Simple plug and play ion source design**

A tool-free source design enables plug and play capability with almost zero maintenance

- **Wide compound class coverage**

The ability to quickly interchange ionization modes between APCI and ESI enables wider compound class coverage and easy and faster method development

## OptiFlow® Turbo V Ion Source – Robustness and Simplicity for Your High Sensitivity Microflow Analyses

- **High-quality spray**

New SteadySpray™ probes ensure consistent droplet formation

- **Maximized peak shape integrity**

Direct column-to-electrode connection – minimizes post column dead volume

- **Tool-free setup**

Based on the trusted Turbo V source design and with finger-tight fittings



- **Retention time reproducibility**

Integrated column heater with an expanded range up to 90°C

- **Eliminate all manual source adjustments**

Intelligent probe recognition supporting a wide flow rate range from 1 – 200  $\mu\text{L}/\text{min}$

# SelexION® Differential Mobility Separation

## Extra Selectivity to Overcome Challenging Ion Separations

**SelexION technology delivers highly-selective, robust and reproducible ion separation that significantly enhances your quantitative and qualitative performance.**

Designed to install between the ionization source and the vacuum interface of your mass spectrometer, SelexION Technology simply installs and de-installs within 2 minutes without breaking vacuum.

- Overcome co-eluting matrix interferences and improve data quality in complex samples

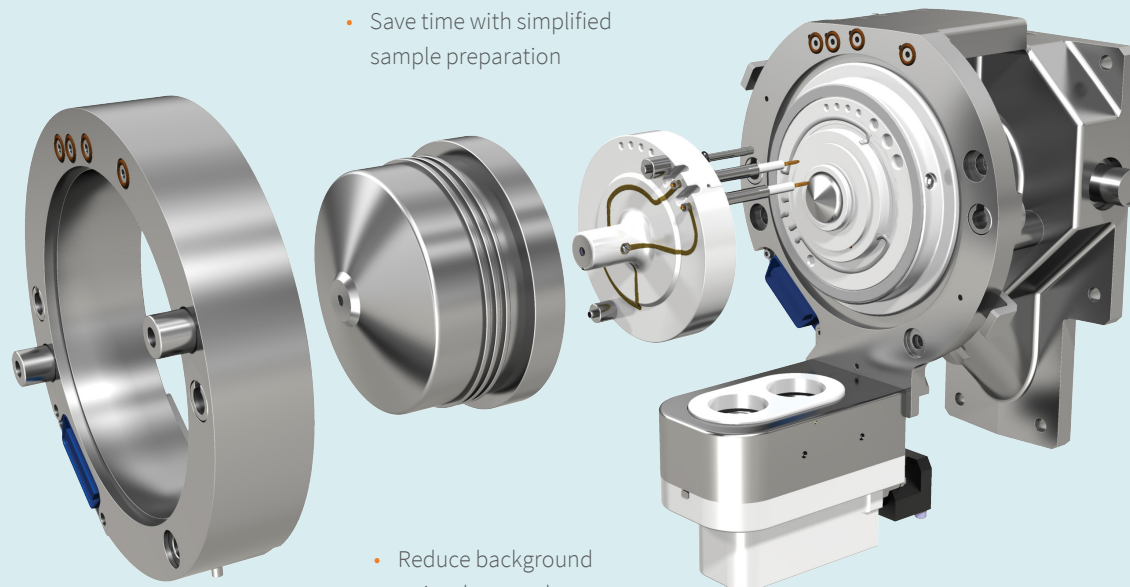

- Save time with simplified sample preparation

- Reduce background noise that may be limiting your LOQ

- Separate isobaric compounds for increased confidence in detection

# QTRAP Ready – So Your Lab is Ready Today for the Analytical Challenges of Tomorrow

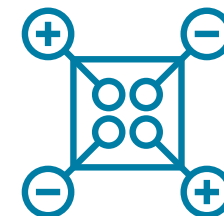

The SCIEX Triple Quad 5500+ LC-MS/MS System comes with an upgrade path to QTRAP functionality. Upon quick license activation, the QTRAP Ready functionality will boost your quantification workflows with additional scan types for more data and information out of the same injection.

- Multiple Reaction Monitoring (MRM), for gold standard LC-MS/MS quantitation
- Enhanced Product Ion (EPI) for added confirmation and greater confidence in your data
- Enhanced MS (EMS) for full scan workflows
- MRM<sup>3</sup> provides quantitative data but also helps remove interferences from highly complex matrices for clear target analyte identification
- Enhanced Multiply Charged (EMC) for an improved signal-to-noise of multiply charged ions
- Enhanced Resolution (ER) for greater resolution on triple quadrupole

# Software Integration to **Power Your Workflows**

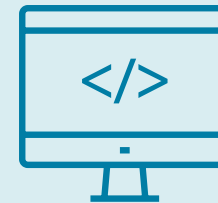

Powerful, workflow-driven software ties everything together to deliver a new benchmark in efficiency, throughput, and productivity. Take full advantage of all the power that the SCIEX 5500+ System puts at your fingertips with fully integrated software designed to enhance fast adoption and easy operation.



## **Analyst® Software – Your Mass Spec Operating System**

Provides state of the art functionality for instrument control, data analysis and reporting with enhanced performance and ease of use.

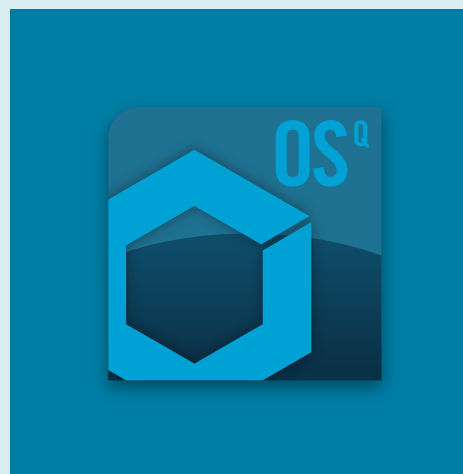

## **SCIEX OS-Q Software – Your Workflow Software Optimized for Qualitative and Quantitative Data Analysis**

Advance your data processing capabilities with ease and confidence. SCIEX OS-Q software is the integrated platform for multiple workflows. From performing high-throughput screening MRM data processing, to non-targeted investigations – all the tools you need are at your fingertips, without sacrificing time, valuable samples, or results. The software simplifies compound identification, quantitation, and data review, so your lab can master the speed, power, and accuracy offered by LC-MS/MS technology.

# SCIEX Now™ Support Network

## The Destination for All Your Support Needs

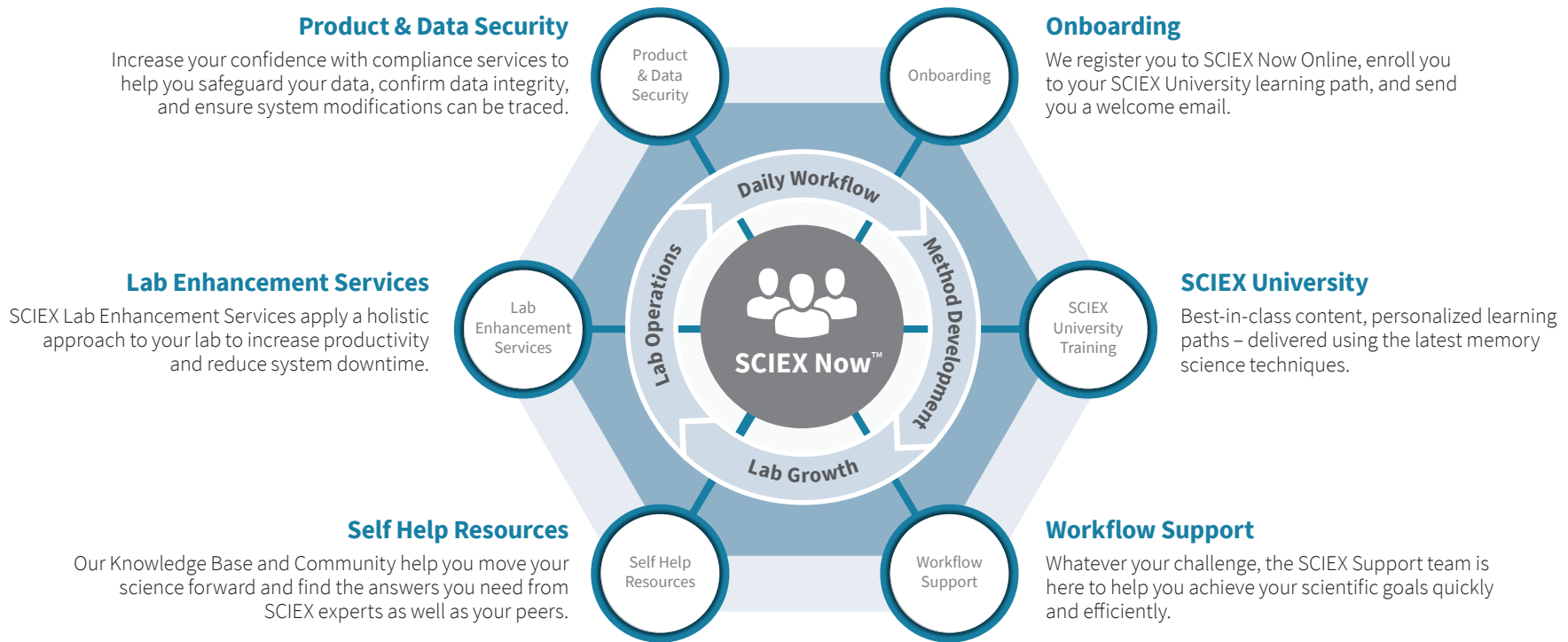

**Start Your Path to Success Now: [sciex.com/sciexnow](https://sciex.com/sciexnow)**

AB Sciex is doing business as SCIEX. © 2019 AB Sciex. For Research Use Only. Not for use in diagnostic procedures. The trademarks mentioned herein are the property of AB Sciex Pte. Ltd. or their respective owners. AB SCIEX™ is being used under license.

RUO-MKT-03-9272-A 06/2019

**Headquarters**  
500 Old Connecticut Path  
Framingham, MA 01701 USA  
Phone 508-383-7700  
[sciex.com](https://sciex.com)

**International Sales**  
For our office locations please call the division headquarters or refer to our website at [sciex.com/offices](https://sciex.com/offices)

**SCIEX**  
The Power of Precision